

Contents

AR-721U

1 Product



2 User Guide

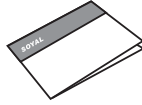

AR-721K

1 Product



2 User Guide

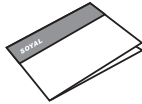

3 Terminal Cables

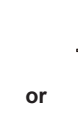
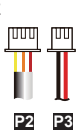

13.56MHz



4 Tools



AR-725U-M

1 Products

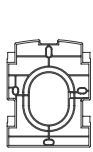

2 User Guide

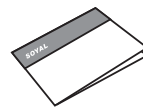

3 Tools



AR-725U

1 Products

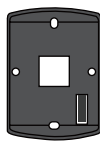

2 User Guide

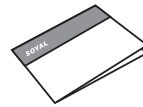

3 Tools



AR-725K-M

1 Products

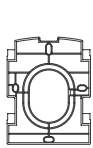

2 User Guide

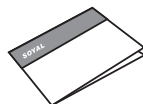

3 Terminal Cables

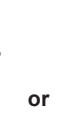
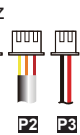

13.56MHz



4 Tools



AR-725K

1 Products

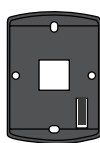

2 User Guide

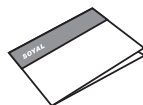

3 Terminal Cables

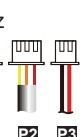
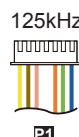

13.56MHz

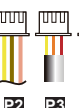

4 Tools



AR-725X

1 Products

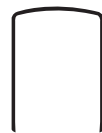
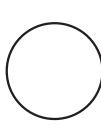
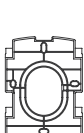
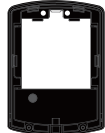

2 Tools



AR-661U [Long Range Proximity Reader]

1 Product



2 User Guide

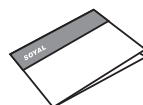

3 Standard Card

[Read Only and Thick]



x2

4 Fittings



x4

Parts Description

- a. Button Head Pozidriv Tapping Screw: M3x10
- b. Button Head Pozidriv Slotting Screw: 2.5x10
- c. Flat Head Cap Phillips Tapping Screw: 4x19.1
- d. Security Torx Screw: M3.5x15
- e. Flat Head Hex Socket Screw: M3x8

AR-721U Terminal Cable (125kHz)

Wire Application	Wire	Color	Description
Power	1	Black	DC Power 0V (GND)
	2	Red	DC Power 12V
Beeper	3	Purple	Beeper Input (Low Sound)
Wiegand	4	Green	Wiegand DAT:0 Output
	5	White	Card Present
Wiegand	6	Blue	Wiegand DAT:1 Output
LED	7	Yellow	LED Red Input (Low Bright)
	8	Brown	LED Green Input (Low Bright)
Beeper	9	Gray	Beeper Output

Output Selection			
Output	232 (TTL)/ABA (DIP_SW1)	26/34 (DIP_SW2)	
WG26	OFF	OFF	
WG34	OFF	ON	
RS-232 (TTL)	ON	OFF	
ABA II	ON	ON	

AR-721U RS-232 (TTL) Format: 9600, N, 8, 1
 DAT:0: TTL Inverted Serial Output.(Connect to PC COM port)
 DAT:1: TTL Serial Output. (Connect to PC COM port through RS-232 invert driver)



WG34
AR-721U [125kHz]

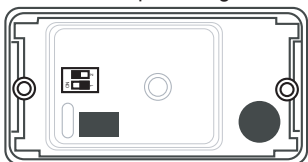

AR-721U Terminal Cable (13.56MHz)

Wire Application	Wire	Color	Description
Power	1	Black	DC Power 0V (GND)
	2	Red	DC Power 12V
Beeper	3	Purple	Beeper Input (Low Sound)
Wiegand	4	Green	Wiegand DAT:0 Output
	5	White	Card Present
Wiegand	6	Blue	Wiegand DAT:1 Output
LED	7	Yellow	LED Red Input
	8	Brown	LED Green Input
Networking Module	9	Gray	RS-485(A+)
	10	Orange	RS-485(B-)

Output Selection		
Output	26/34(DIP_SW1)	232(TTL)/ABA(DIP_SW2)
WG26	ON	OFF
WG34	OFF	OFF
ABAI	OFF	ON
RS-232(TTL)	ON	ON



WG34
AR-721U [13.56MHz]

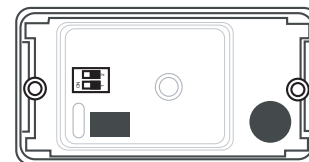

AR-721U Protocol Description

[i.e.] Card Number = 01234:56789

Echo	Value	Description		
Head	7E	Initial Value		
Length	09	Compute the data length from Node to the end including XOR and SUM		
Node Function	00	The value 00 is fixed, the message would be sent to PC from the device		
Data Field	71	Data receiving from AR-721U		
	04	Site H	Site Code – High	Site Hi Site Lo = 0x4D2
	D2	Site L	Site Code – Low	Site Code: 01234
	DD	Card H	Card Code – High	Card Hi Card Lo = 0xDDD5
	D5	Card L	Card Code – Low	Card Code: 56789
XOR	01	CID	ID Code [Bits(39~32)]	
SUM	51	XOR=FF^00^71^04^D2^DD^D5^01 =51		
	4B	SUM=(00+71+04+D2+DD+D5+01+51) · FF=4B(LSB)		

AR-721U/AR-725U Networking Diagram

Mifare[13.56MHz]

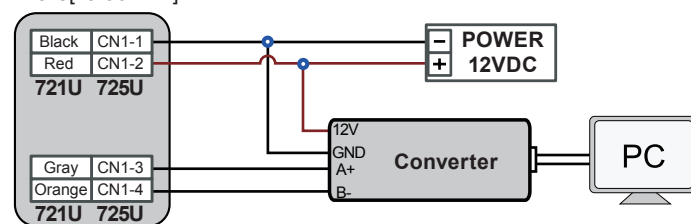

AR-721U	AR-725U	Function
Black	CN1-1	DC 0V
Red	CN1-2	DC 12V
Gray	CN1-3	RS-485(A+)
Orange	CN1-4	RS-485(B-)

AR-725U Terminal Cable (125kHz)

AR-725U [125kHz] CN1

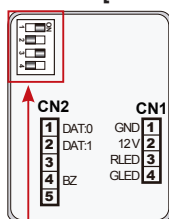

Wire Application	Wire	Name	Description
Power	1	GND	DC Power 0V
	2	12V	DC Power 12V
LED	3	RLED	LED Red Input (Low Bright)
	4	GLED	LED Green Input (Low Bright)

CN2

Wire Application	Wire	Name	Description
Wiegand	1	DAT: 0	Wiegand DAT: 0 Output
	2	DAT: 1	Wiegand DAT: 1 Output
Beeper	3	CP	Card Present
	4	BZ	Beeper Input(Low Sound)
	5	---	---

Dip-switch

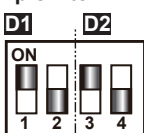

D1	Output format	DIP_SW1	DIP_SW2
	ABA_II / OMRON	ON	ON
	WG-38	OFF	ON
	WG-34	ON	OFF
	WG-26	OFF	OFF

D2	Indicator while card present	DIP_SW3	DIP_SW4
	Red LED On	ON	ON
	Green LED On	OFF	ON
	Red LED & Beep On	ON	OFF
	No LED or Beep sound	OFF	OFF

AR-725U Terminal Cable (13.56MHz)

AR-725U [13.56MHz] CN1

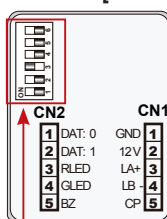

Wire Application	Wire	Name	Description
Power	1	GND	DC Power 0V
	2	12V	DC Power 12V
Networking	3	LA+	RS-485(A+)
	4	LB-	RS-485(B-)
	5	CP	Card Present

CN2

Wire Application	Wire	Name	Description
Wiegand	1	DAT: 0	Wiegand DAT: 0 Output
	2	DAT: 1	Wiegand DAT: 1 Output
LED	3	RLED	LED Red Input (Low Bright)
	4	GLED	LED Green Input (Low Bright)
Beeper	5	BZ	Beeper Input (Low Sound)

Dip-switch

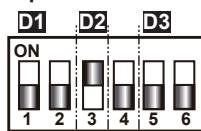

D1	Output format	DIP_SW1	DIP_SW2
	WG-26	ON	OFF
	WG-34	OFF	OFF
	ABA_II	OFF	ON
	RS-232(TTL)	ON	ON

D2	DIP_SW3	D3	DIP_SW5	DIP_SW6
	Open RS-485	ON		
	Open RFID_SIM	OFF		

D3	DIP_SW5	DIP_SW6
	725UD	OFF
	725UD_M	ON

AR-661U Terminal Cable (125kHz only)

Installation Notice

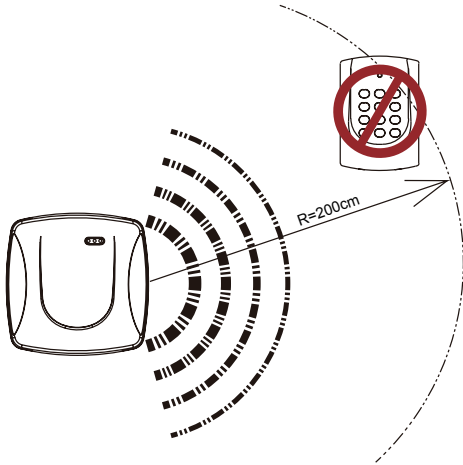

※ Minimum distance between AR-661U & other proximity reader should be over 200cm; otherwise, both readers might interfere each other.

Wire Application	Wire	Color	Description	Remark
Power	1	Black	DC 0V (GND)	regulated
	2	Red	DC 12V~18V	
Beeper	3	Purple	Beeper Output	
Wiegand	4	Green	Wiegand DAT:0	Open collected
	5	White	Card Present	
Wiegand	6	Blue	Wiegand DAT:1	Open collected
Output Selection	7	Yellow	SET1	
	8	Brown	SET2	
	9	Gray	SET3	Reserve

Output Selection

Output	WG26	WG34	RS-232 (TTL)	WG34 + 4
SET 1	Open	Short to GND	Open	Short to GND
SET 2	Open	Open	Short to GND	Short to GND

※ Note:

WG34+4: Follow 0101 after WG34 data stream for reader identification.

AR-661U Installation

721H with 2 pcs of 661U for two-door anti-pass-back

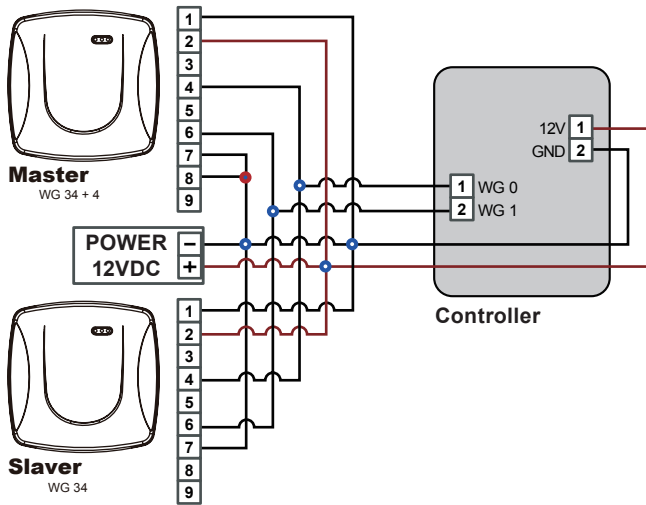

Improvement of RF interference for 2 pcs of 661U

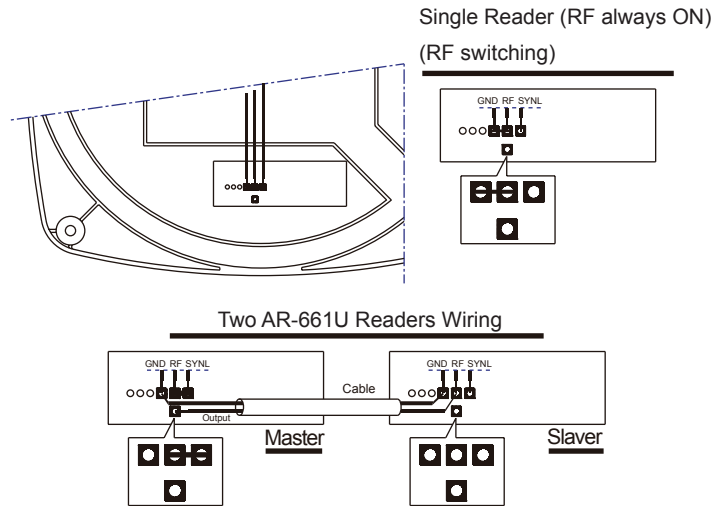

※ When the distance between two AR-661U readers is less than 6m (recommended value), the sensing distance will be shortened. However, you can use this method to avoid interference.

AR-721U/AR-725U/AR-661U Diagram

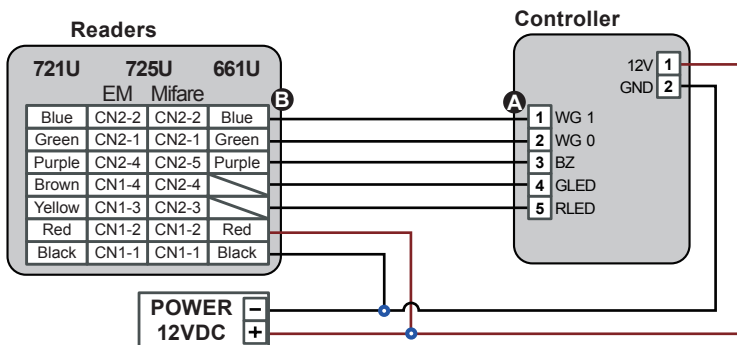

※ No 661U needs to connect to LED

③ AR-721U	③ AR-725U	③ AR-661U	① PIN	Function
Blue	CN2-2	CN2-2	Blue	DAT: 1
Green	CN2-1	CN2-1	Green	DAT: 0
Purple	CN2-4	CN2-5	Pink	BEEP
Brown	CN1-4	CN2-4	Brown	G-LED
Yellow	CN1-3	CN2-3	Yellow	R-LED

721K/725K Terminal Cable (125kHz)

Cable: P1

Wire Application	Wire	Color	Description
Wiegand / ABA	1	Thin Blue	Wiegand DAT: 1 Input ABA Format: Clock
	2	Thin Green	Wiegand DAT: 0 Input ABA Format: Data
	3	Orange	ABA Format: Card Present
	4		No Connection
Beeper	5	Pink	Beeper Input (Low Sound)
LED	6	Brown	LED Green Input (Low Bright)
	7	Yellow	LED Red Input (Low Bright)

Cable: P2

Wire Application	Wire	Color	Description
Tamper Switch	1	Red	N.C.
	2	Orange	COM
	3	Yellow	N.O.

Cable: P3

Wire Application	Wire	Color	Description
Power	1	Thick Red	DC Power 12V
	2	Thick Black	DC Power 0V

Wiegand Output Format

Output Format	WG	J2	RST/Bits
Wiegand 26 Bit	Open	Open	Open
Wiegand 34 Bit	Open	Open	Short
RS-232	Short	Open	Open
Magnetic (ABA 8 Digital)	Short	Open	Short
Magnetic(ABA 10 Digital)	Short	Open	Open

EM(125kHz)

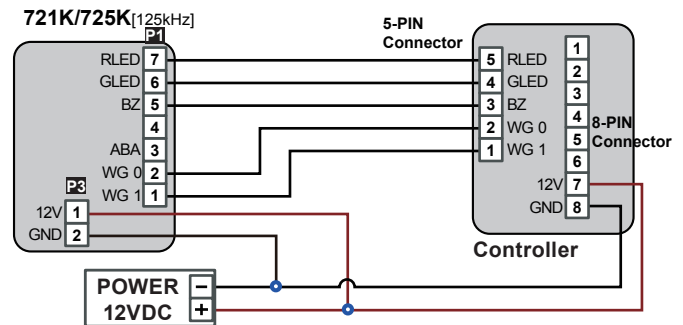

※ Cable position is showed in the Terminal Cable

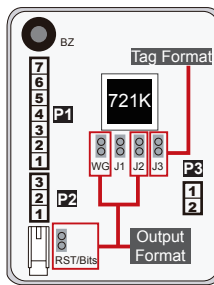

AR-721K [125kHz]

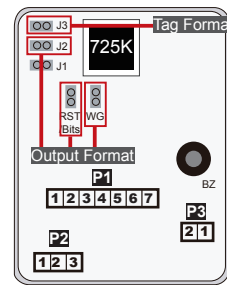

AR-725K [125kHz]

Tag Format	J3
SOYAL Format	Short
EM Format [Default]	Open

721K/725K Terminal Cable (13.56MHz)

Cable: P1

Wire Application	Wire	Color	Description
Output Format	1	Orange	SET2
	2	Purple	SET1
	3	White	ABA Format / Reading card
Power	4	Thick Red	DC 12V
	5	Thick Black	DC 0V (GND)

Cable: P2

Wire Application	Wire	Color	Description
Beeper	1	Pink	Beeper Input (Input Low)
LED	2	Brown	LED Green Input (Input Low)
	3	Yellow	LED Red Input (Input Low)

Cable: P3

Wire Application	Wire	Color	Description
Tamper Switch	1	Red	N.C.
	2	Orange	COM
	3	Yellow	N.O.

Cable: P4

Wire Application	Wire	Color	Description
2-PIN Connector	1	Green	WG DAT:0 Output ABA Format: Data
	2	Blue	WG DAT:1 Input ABA Format: Clock

Cable: P5

Wire Application	Wire	Color	Description
Networking	1	Thick Green	RS-485 (B-)
Module	2	Thick Blue	RS-485 (A+)

Mifare(13.56MHz)

721K/725K[13.56MHz]

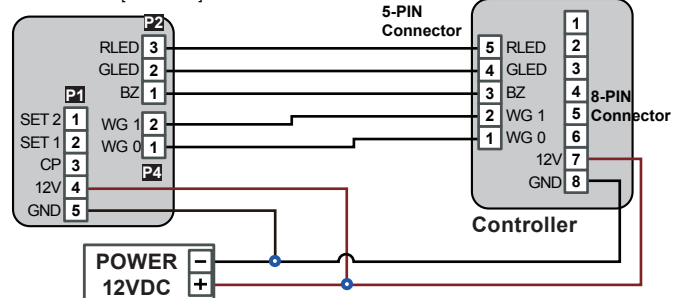

※ Cable position is showed in the Terminal Cable

Output Format

Output Format	SET 1	SET 2	Note
WG-26	Open	Open	Hex
WG-34	Open	Short to GND	Hex
ABA-10	Short to GND	Open	BCD 10
ABA-5-5	Short to GND	Short to GND	BCD 5:5

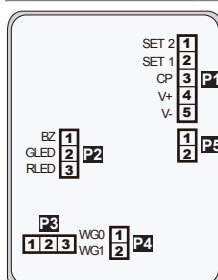

AR-721K [13.56MHz]

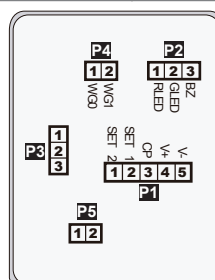

AR-725K [13.56MHz]

